



Micro Detectors

Italian Sensors Technology



Cylindrical
Ultrasonic Sensor M18
UK1 with Teach-in function



Ultrasonic Sensors
Catalogue

Cod. CAT3EUK1476202

Datasheet - UK1 - english - Ed.01/2015





Products

M18
cylindrical



Series UK1

M18 cylindrical



www.microdetectors.com

sectors and applications

garbage disposal
Packaging Industry
Glass Industry
Level control
earth moving machinery and equipment
storage system



features

Models with digital output: two programmable outputs and single adjustable output detection

Models with current or voltage analogue outputs: programmable switching points and slope outputs to optimize the resolution

Working area adjusting (window teach or on object teach) by Teach-in button suitable for all models for a fast coming into work

Multifunction LED indicator: output state, adjustment procedure, NO/NC selection and reverse analog output slope

Plastic and AISI 316L stainless steel housing, cable and plug connector exit with 4 pins

Adjustable Hysteresis function: model with programmable double digital outputs, specific for levels

approvals



protection degree

IP67





Products

M18
cylindrical

M18 cylindrical ultrasonic sensor UK1

UK1 product is an M18 ultrasonic sensor, with **both plastic housing and AISI 316L stainless steel**, that works in direct diffuse mode on four different working ranges reaching up to 2.200 mm of maximum working distance.

Through the use of **Teach-in button** it is possible to set the working distance, the output status (NO/NC) and the slope of analog output and to change function on the model with hysteresis function. A single orange LED indicator, visible through the transparent plug and cable exit, furnish information about the output and the regulation procedure.

All the UK1 models are **temperature compensated**, ensuring reliability in the detection for entire working range.

UK1 sensors have a housing totally filled of resin, to be suitable for applications subject to vibrations, and boast of **IP67** protection grade.

pack content

Installation manual (english + italian): CAT8BUK1365401 (UK1A), CAT8BUK1365501 (UK1C), CAT8BUK1365601 (UK1D), CAT8BUK1363502 (UK1F)

Dangerous areas safety manual (ATEX versions only)

CE declaration of conformity (ATEX versions only)

ATEX marking label (solo versioni ATEX)

2 plastic nuts or 2 metallic nuts

2 flexible washers

further commercial and technical documents available

High resolution pictures

Application notes:

- Control of stabilizer extension for hydraulic cranes (italian: CAT3IUK1261667, english: CAT3EUK1261668 and spanish: CAT3SUK1261669)
- Presence control of operators for waste collection vehicles (italian: CAT3IUK1261667, english: CAT3EUK1261668 and spanish: CAT3SUK1261669)
- Level check in the underground solid urban waste collection and disposal depots (italian: CAT3IUK1261667, english: CAT3EUK1261668 and spanish: CAT3SUK1261669)

custom models already tested

-

minimum quantity that can be ordered

1 piece

UK R 1 A / E 1 - 0 E ULAN

UK	M18 ultrasonic sensor
	Diffuse models
R	Retroreflective models
1	Standard housing
A	Direct diffuse 50 - 400 mm / Retroreflective 100 - 400 mm
C	Direct diffuse 100 - 800 mm / Retroreflective 150 - 800 mm
D	Direct diffuse 150 - 1,600 mm (200 - 1.500 metal housing) / Retroreflective 250 - 1,600 mm
F	Direct diffuse 200 - 2,200 mm / Retroreflective 300 - 2,200 mm
E	Adjustment by Teach-in button
1	0...10 V single voltage analogue output
2	4...20 mA single current analogue output
4	NPN - NO/NC digital output + 4 ... 20 mA current analogue output
6	PNP - NO/NC digital output + 4 ... 20 mA current analogue output
7	PNP - NO/NC digital output + 0 ... 10 V voltage analogue output
9	NPN - NO/NC digital output + 0 ... 10 V voltage analogue output
N	NPN - NO/NC single digital output
P	PNP - NO/NC single digital output
W	PNP - two digital outputs with standard window and adjustable hysteresis functions (*)
M	NPN - two digital outputs with standard window and adjustable hysteresis functions (*)
0	Plastic housing
1	AISI 316L (DIN 1.4404) stainless steel housing
2	90° emission, plastic housing
E	M12 plug cable exit
A	Axial cable exit
UL	With cULus certification
AN	ATEX certified, Cat. 3 Zone 2,22 (*)

(*) The transition between the two functions takes place by pressing the "teach-in" button for more than 8 seconds, until the status LED will flash quickly. Release the button and the LED will flash slowly. When the LED stops flashing, the function is changed. In the standard window function the state selection was done by wires reversing on the plc controller (NO / NC). See the "Output curve" section.

(**) Only for the PNP plug version.



Products

M18
cylindrical

single digital output standard cULus certified available models

dimension	function	distance	housing	output	analog output 0...10 V	analog output 4...20 mA	1 x PNP - NO/NC	1 x NPN - NO/NC
M18	direct diffuse	50...400 mm	plastic	M12 connector	UK1A/E1-0EUL	UK1A/E2-0EUL	UK1A/EP-0EUL	UK1A/EN-0EUL
		100...800 mm			UK1C/E1-0EUL	UK1C/E2-0EUL	UK1C/EP-0EUL	UK1C/EN-0EUL
		150...1.600 mm			UK1D/E1-0EUL	UK1D/E2-0EUL	UK1D/EP-0EUL	UK1D/EN-0EUL
		200...2.200 mm			UK1F/E1-0EUL	UK1F/E2-0EUL	UK1F/EP-0EUL	UK1F/EN-0EUL
		50...400 mm		cable	UK1A/E1-0AUL	UK1A/E2-0AUL	UK1A/EP-0AUL	UK1A/EN-0AUL
		100...800 mm			UK1C/E1-0AUL	UK1C/E2-0AUL	UK1C/EP-0AUL	UK1C/EN-0AUL
		150...1.600 mm			UK1D/E1-0AUL	UK1D/E2-0AUL	UK1D/EP-0AUL	UK1D/EN-0AUL
		200...2.200 mm			UK1F/E1-0AUL	UK1F/E2-0AUL	UK1F/EP-0AUL	UK1F/EN-0AUL

double digital output standard cULus certified available models

dimension	function	distance	housing	output	2 x PNP (hysteresys function+ standard window output)	2 x NPN (hysteresys function+ standard window output)
M18	direct diffuse	50...400 mm	plastic	connector M12	UK1A/EW-0EUL	UK1A/EM-0EUL
		100...800 mm			UK1C/EW-0EUL	UK1C/EM-0EUL
		150...1.600 mm			UK1D/EW-0EUL	UK1D/EM-0EUL
		200...2.200 mm			UK1F/EW-0EUL	UK1F/EM-0EUL
		50...400 mm		cable	UK1A/EW-0AUL	UK1A/EM-0AUL
		100...800 mm			UK1C/EW-0AUL	UK1C/EM-0AUL
		150...1.600 mm			UK1D/EW-0AUL	UK1D/EM-0AUL
		200...2.200 mm			UK1F/EW-0AUL	UK1F/EM-0AUL
		50...400 mm	stainless steel AISI 316L	connector M12	UK1A/EW-1EUL	UK1A/EM-1EUL
		100...800 mm			UK1C/EW-1EUL	UK1C/EM-1EUL
		200...1.500 mm			UK1D/EW-1EUL	UK1D/EM-1EUL
		50...400 mm			cable	UK1A/EW-1AUL
		100...800 mm		UK1C/EW-1AUL		UK1C/EM-1AUL
		200...1.500 mm		UK1D/EW-1AUL		UK1D/EM-1AUL

double output cULus certified available models

dimension	function	distance	housing	output	1 x PNP - NO/NC + 1 x 4...20 mA	1 x NPN - NO/NC + 1 x 4...20 mA	1 x PNP - NO/NC + 1 x 0...10 V	1 x NPN - NO/NC + 1 x 0...10 V
M18	direct diffuse	50...400 mm	plastic	connector M12	UK1A/E6-0EUL	UK1A/E4-0EUL	UK1A/E7-0EUL	UK1A/E9-0EUL
		100...800 mm			UK1C/E6-0EUL	UK1C/E4-0EUL	UK1C/E7-0EUL	UK1C/E9-0EUL
		150...1.600 mm			UK1D/E6-0EUL	UK1D/E4-0EUL	UK1D/E7-0EUL	UK1D/E9-0EUL
		200...2.200 mm			UK1F/E6-0EUL	UK1F/E4-0EUL	UK1F/E7-0EUL	UK1F/E9-0EUL
		50...400 mm		cable	UK1A/E6-0AUL	UK1A/E4-0AUL	UK1A/E7-0AUL	UK1A/E9-0AUL
		100...800 mm			UK1C/E6-0AUL	UK1C/E4-0AUL	UK1C/E7-0AUL	UK1C/E9-0AUL
		150...1.600 mm			UK1D/E6-0AUL	UK1D/E4-0AUL	UK1D/E7-0AUL	UK1D/E9-0AUL
		200...2.200 mm			UK1F/E6-0AUL	UK1F/E4-0AUL	UK1F/E7-0AUL	UK1F/E9-0AUL
		50...400 mm	stainless steel AISI 316L	connector M12	UK1A/E6-1EUL	UK1A/E4-1EUL	UK1A/E7-1EUL	UK1A/E9-1EUL
		100...800 mm			UK1C/E6-1EUL	UK1C/E4-1EUL	UK1C/E7-1EUL	UK1C/E9-1EUL
		200...1.500 mm			UK1D/E6-1EUL	UK1D/E4-1EUL	UK1D/E7-1EUL	UK1D/E9-1EUL
		50...400 mm			cable	UK1A/E6-1AUL	UK1A/E4-1AUL	UK1A/E7-1AUL
		100...800 mm		UK1C/E6-1AUL		UK1C/E4-1AUL	UK1C/E7-1AUL	UK1C/E9-1AUL
		200...1.500 mm		UK1D/E6-1AUL		UK1D/E4-1AUL	UK1D/E7-1AUL	UK1D/E9-1AUL
				UK1F/E6-1AUL		UK1F/E4-1AUL	UK1F/E7-1AUL	UK1F/E9-1AUL

cULus and ATEX certified available models

dimension	function	distance	housing	output	analogue output 0...10 V	analogue output 4...20 mA	1xPNP - NO/NC	1 x PNP NO/NC + 1 x 4...20 mA	1 x PNP NO/NC + 1 x 0...10 V
M18	direct diffuse	50...400 mm	plastic	connector M12	UK1A/E1-0EULAN	UK1A/E2-0EULAN	UK1A/EP-0EULAN	UK1A/E6-0EULAN	UK1A/E7-0EULAN
		100...800 mm			UK1C/E1-0EULAN	UK1C/E2-0EULAN	UK1C/EP-0EULAN	UK1C/E6-0EULAN	UK1C/E7-0EULAN
		150...1.600 mm			UK1D/E1-0EULAN	UK1D/E2-0EULAN	UK1D/EP-0EULAN	UK1D/E6-0EULAN	UK1D/E7-0EULAN
		200...2.200 mm			UK1F/E1-0EULAN	UK1F/E2-0EULAN	UK1F/EP-0EULAN	UK1F/E6-0EULAN	UK1F/E7-0EULAN



Products

M18
cylindrical

retroreflective available models







dimension	distance	housing	output	PNP NO/NC	NPN NO/NC
M18	100...400 mm	plastic	connector M12	UKR1A/EP-0EUL	UKR1A/EN-0EUL
	150...800 mm			UKR1C/EP-0EUL	UKR1C/EN-0EUL
	250...1.600 mm			UKR1D/EP-0EUL	UKR1D/EN-0EUL
	300...2.200 mm			UKR1F/EP-0EUL	UKR1F/EN-0EUL
	100...400 mm		cable	UKR1A/EP-0AUL	UKR1A/EN-0AUL
	150...800 mm			UKR1C/EP-0AUL	UKR1C/EN-0AUL
	250...1.600 mm			UKR1D/EP-0AUL	UKR1D/EN-0AUL
	300...2.200 mm			UKR1F/EP-0AUL	UKR1F/EN-0AUL

90° emission available models

dimension	distance	housing	output	analogue output 0...10 V	analogue output 4...20 mA	PNP - NO/NC 4...20 mA	NPN - NO/NC 4...20 mA	2 x PNP isteresi/finestra	2 x PNP isteresi/finestra
M18	50...400 mm	plastic	connector M12	UK1A/E7-2EUL	UK1A/E9-2EUL	UK1A/E6-2EUL	UK1A/E4-2EUL	UK1A/EW-2EUL	UK1A/EM-2EUL
	150...1.600 mm			UK1D/E7-2EUL	UK1D/E9-2EUL	UK1D/E7-2EUL	UK1D/E4-2EUL	UK1D/EW-2EUL	UK1D/EM-2EUL
	200...2.200 mm			UK1F/E7-2EUL	UK1F/E9-2EUL	UK1F/E6-2EUL	UK1F/E4-2EUL	UK1F/EW-2EUL	UK1F/EM-2EUL

cULus certified available models

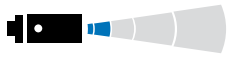
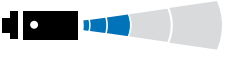
according to IEC EN 60947-5-2 and ICE EN 60947-5-7

				
models	UK1A/E*-**UL	UK1C/E*-**UL	UK1D/E*-**UL	UK1F/E*-0*UL
				
maximum sensing distance	400 mm ⁽¹⁾	800 mm ⁽²⁾	1.600 mm/ 1500 mm metallic housing ⁽²⁾	2.200 mm ⁽²⁾
minimum sensing distance (blind zone)	50 mm	100 mm	150 mm/ 200 mm metallic housing	200 mm
sensing range	100 - 400 mm	100 - 800 mm	150 - 1.600 mm / 200-1.500 metallic housing	200 - 2.200 mm
beam angle	± 8°	± 7°	± 8° / ± 7° metallic housing	± 7°
switching frequency (digital output)	10 Hz	4 Hz	2 Hz / 1Hz metallic housing	1 Hz
response time (digital output)	500 ms	≤ 125 ms	250 ms / 500 ms metallic housing	500 ms
hysteresys	1%			
repeat accuracy	0,5%			
linearity error	1%			
temperature range	-20°C ...+60°C			
temperature compensation	yes			
operating voltage	15 - 30 Vcc			
thermal drift	≤ 7%			
ripple	5%			
leakage current	10 µA @ 30 Vcc			
output voltage drop	2,2 V max. (IL=100mA)			
no-load current	≤ 50 mA			
output current (digital output)	100 mA			
minimum load resistance (analog voltage output)	3 k Ω			
adjustment set point	Teach-in button			
time delay before availability (digital output)	≤ 500 ms, ≤ 900 ms (double digital output)			
time delay before availability (analog output)	≤ 900 ms			
supply electrical protections	Polarity reversal, transient			
digital output electrical protections	Short circuit (auto reset), overvoltage pulses			
analog output electrical protections	Overvoltage pulses			
EMC	Conforming to the EC Directive 2004/108/EC requirements according to EN 60947-5-2			
protection degree	IP67 (EN60529) ⁽³⁾			
housing material	PBT/stainless steel AISI 316L			PBT
front end material	Epoxy-Glass resin			
tightening torque	50 Nm			
weight	26 g (connector exit); 88 g (cable exit) / 55 g (connector exit); 125 gr (cable exit) metallic housing			
storage temperature	-35°C...+70° without freezing			

⁽¹⁾ Metallic target 100 x 100 mm

⁽²⁾ Metallic target 200 x 200 mm

⁽³⁾ Protection guarantee only with plug cable well mounted

As usual, in industrial environments, we recommend to use shielded cables in order to prevent possible disturbances on the devices caused by electromagnetic induced fields.



Products

M18
cylindrical



retroreflective available models

according to IEC EN 60947-5-2 and ICE EN 60947-5-7

				
models	UKR1A/EP-*E	UKR1C/EP-*E	UKR1D/EP-*E	UKR1F/EP-*E
				
Nominal sensing distance S_n	400 mm ⁽¹⁾	800 mm ⁽²⁾	1.600 mm	2.200 mm
Background minimum distance	100 mm	150 mm	250 mm	300 mm
Beam angle	$\pm 8^\circ$	$\pm 7^\circ$	$\pm 8^\circ$	$\pm 7^\circ$
Switching frequency	8 Hz	3 Hz	1 Hz	1 Hz
Supply voltage range	15...30 Vdc			
Max. ripple content	5%			
Output state	PNP or NPN, NO/NC selectable			
Output current	100 mA			
Output voltage drop	$\leq 2,2$ V (@ I = 100mA)			
No load supply current	≤ 50 mA @ Val=24V			
Leakage current	≤ 10 μ A @ 30V			
Time delay before availability	≤ 500 ms			
Ambient temperature range	- 20°C...+ 60°C			
Temperature drift of S_r	≤ 5 %			
Short circuit protection	• (autoreset)			
Induction protection	•			
Voltage reversal protection	•			
Weight	Plastic housing: 26g			
LED indicators	Yellow: output			
Protection degree	IP67			
EMC protection	IEC60947-5-2			
Housing material	Plastic housing: PBT			
Sensing face	Epoxy glass resin			
Connection	M12 plug cable exit			

90° emission available models

according to IEC EN 60947-5-2 and ICE EN 60947-5-7

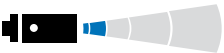
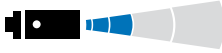
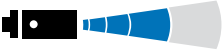
			
models	UK1A/E*-2EUL	UK1D/E*-2EUL	UK1F/E*-2EUL
			
Nominal sensing distance S_n	400 mm	1.600 mm	2.200 mm
Minimum distance	50 mm	150 mm	200 mm
Working range	50...400 mm	150...1.600 mm	200...2.200 mm
Beam angle	$\pm 8^\circ$	$\pm 8^\circ$	$\pm 7^\circ$
Hysteresis	1%		
Repeat accuracy	0,5%		
Switching frequency	10 Hz	2 Hz	1 Hz
Response time	500 ms		
Supply voltage range	15...30 Vcc		
Max. ripple content	7%		
Output current	100 mA (digital output)		
Output voltage drop	$\leq 2,2 \text{ V (@ } I = 100\text{mA)}$		
No load supply current	$\leq 50 \text{ mA}$		
Leakage current	$\leq 10 \mu\text{A @ } 30\text{V}$		
Time delay before availability	$\leq 900 \text{ mA}$		
Ambient temperature range	- 20°C...+ 60°C		
Temperature drift of Sr	$\leq 5\%$		
Short circuit protection (digital output)	• (autoreset)		
Induction protection	•		
Voltage reversal protection	•		
Weight	Plastic housing: 58g		
LED indicators	Green: echo – Yellow: output		
Protection degree	IP67		
Housing material	Plastic housing: PBT		
Sensing face	Glass epoxy resin		
Connection	M12 plug cable exit		



Products

M18
cylindrical

- BN** brown
- BU** blue
- BK** black
- WH** white

electrical diagrams of connections

PNP NO/NC + analogue output models

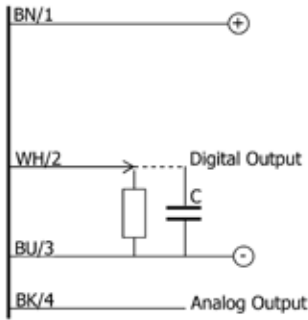

PNP models with double output

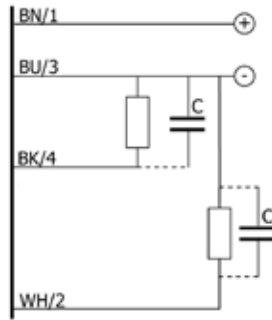

PNP NO/NC models with single digital output

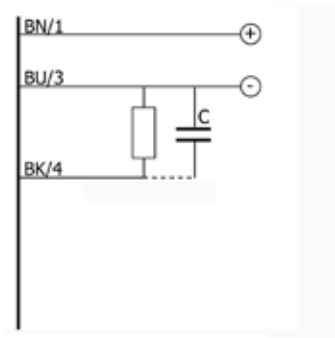

Models with single analogue output

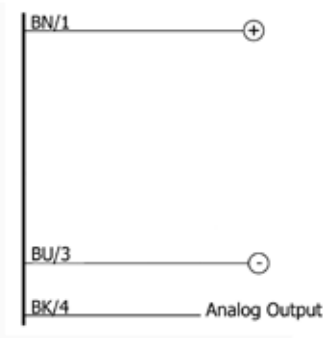

NPN NO/NC + analogue output models

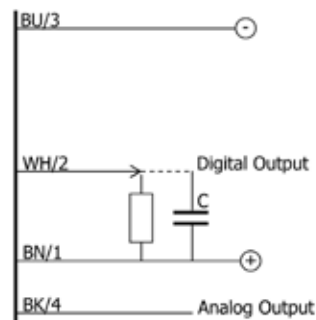

NPN models with double output

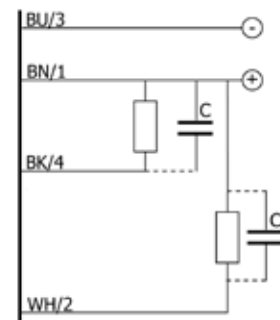

NPN NO/NC models with single digital output

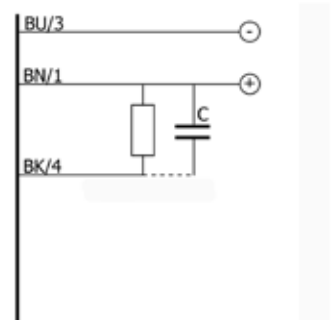

M12

- UK1*/E7-*E**
- UK1*/E6-*E**
- UK1*/E4-*E**
- UK1*/E9-*E**

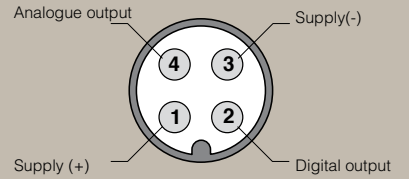

- UK1*/EW-*E**
- UK1*/EM-*E**

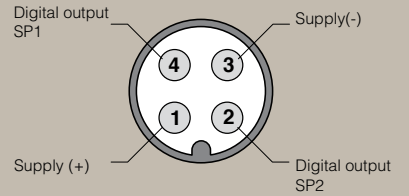

- UK1*/E1-0E**
- UK1*/E2-0E**
- UK1*/EP-0E**
- UK1*/EN-0E**

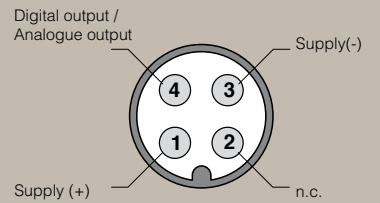

available outputs

Models with single digital output



Models with single analogue output



Models with double digital output - standard window and adjustable hysteresis outputs

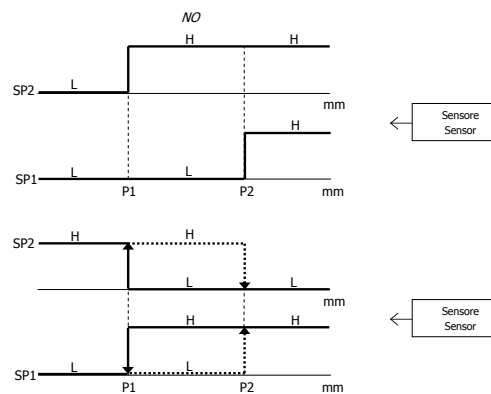

Models with digital output + analogue output*

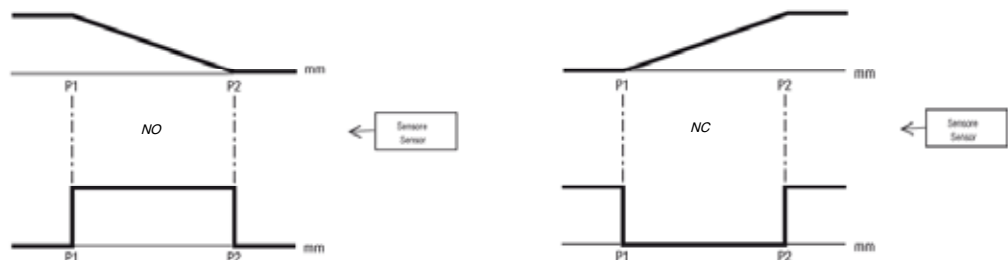

⁽¹⁾ It can be used as a single model output.

P1 maximum selected working distance and first point to select

P2 minimum selected working distance and second point to select



Products

M18
cylindrical

response diagram

UK1A/**-0*

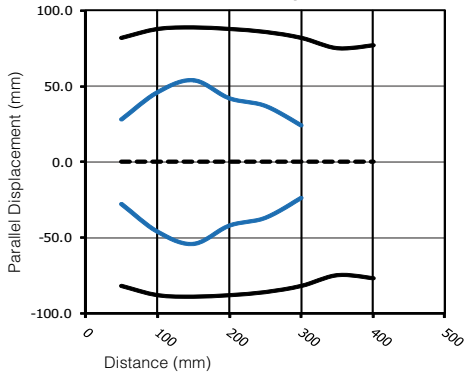

UK1A/**-1*

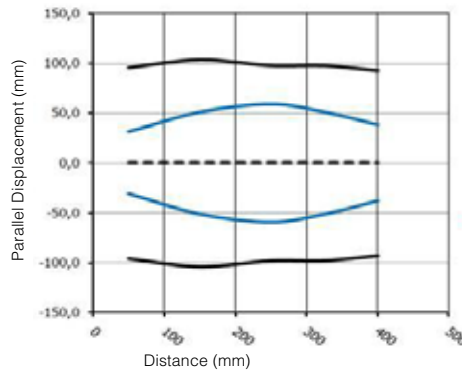

— Target 100 x 100 mm
- - - - Round bar dia. 25 mm

UK1C/**-****

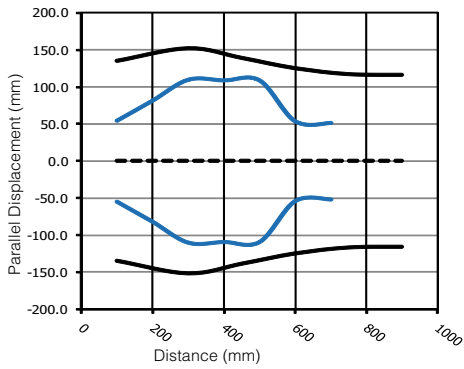

— Target 200 x 200 mm
- - - - Round bar dia. 25 mm

UK1D/**-0*

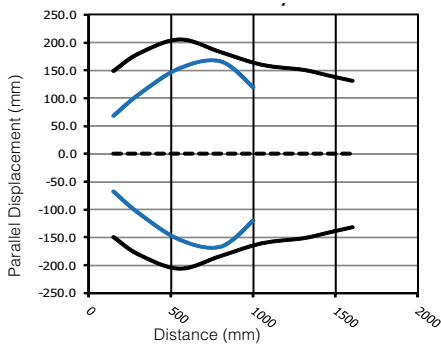

UK1D/**-1*

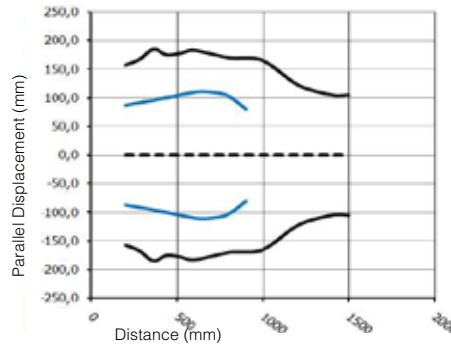

— Target 200 x 200 mm
- - - - Round bar dia. 25 mm

UK1F/**-****

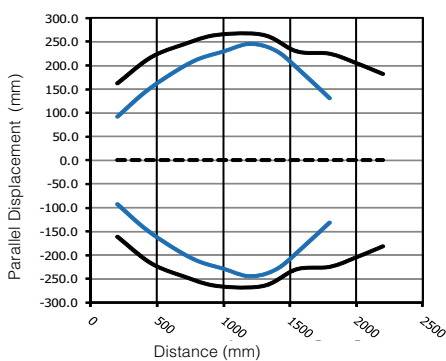

— Target 200 x 200 mm
- - - - Round bar dia. 25 mm

dimensions

UK1*/**-0A

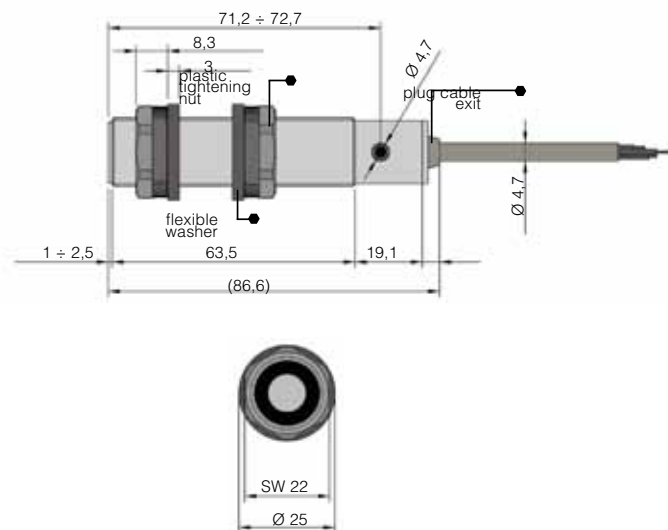

UK1*/**-1A

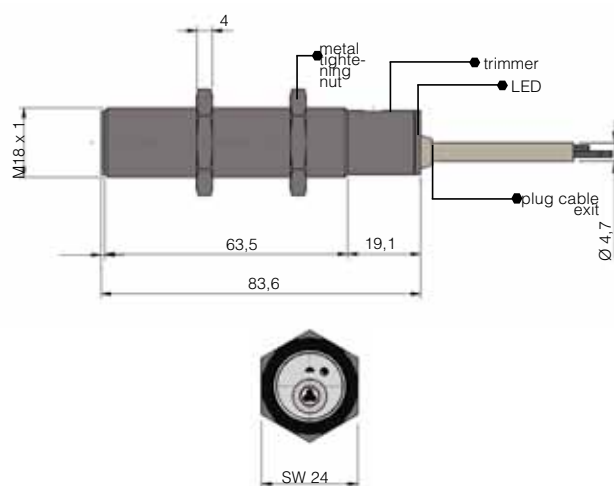

UK1*/**-0E

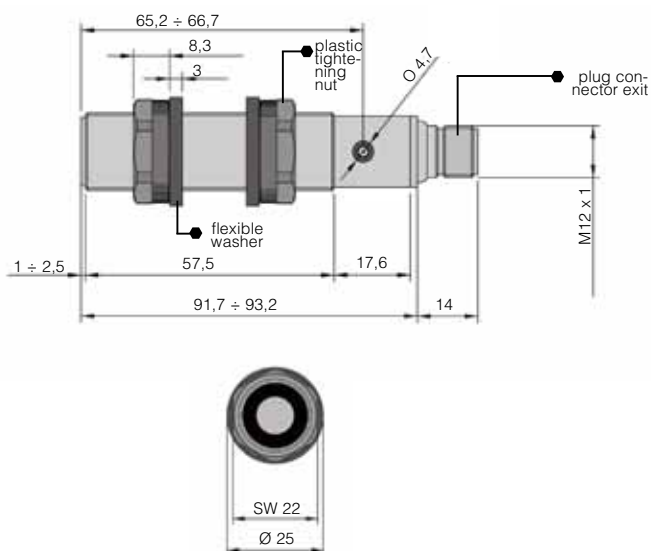

UK1*/**-1E

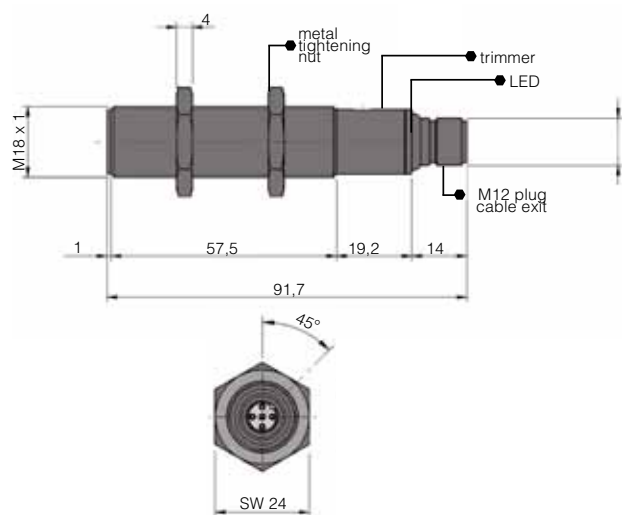

UKR1*/**-2E

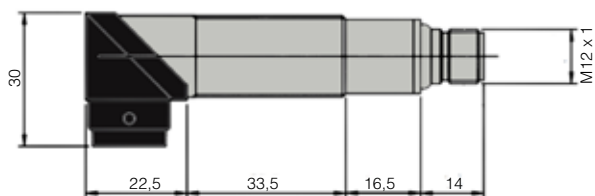



Catalogue
Ultrasonic Sensors



CAT3EUK1476202 ULTRASONIC SENSORS CATALOGUE UK1 ENG ED.01/2015

All information written in this catalogue are subject to modifications without notice.
They don't represent any obligation for M.D. Micro Detectors

Any variation will be implemented in this catalogue and its electronic version, available on the corresponding page of M.D. Micro Detectors website:
www.microdetectors.com